



USER MANUAL

**Elo Touch Solutions
1915L Touchmonitors**

SW600066 Rev J

No part of this publication may be reproduced, transmitted, transcribed, stored in a retrieval system, or translated into any language or computer language, in any form or by any means, including, but not limited to, electronic, magnetic, optical, chemical, manual, or otherwise without prior written permission of Elo Touch Solutions, Inc.

Disclaimer

The information in this document is subject to change without notice. Elo Touch Solutions, Inc. and its Affiliates (collectively "Elo") makes no representations or warranties with respect to the contents herein, and specifically disclaims any implied warranties of merchantability or fitness for a particular purpose. Elo reserves the right to revise this publication and to make changes from time to time in the content hereof without obligation of Elo to notify any person of such revisions or changes.

Trademark Acknowledgments

AccuTouch, CarrollTouch, Elo, Elo (logo), Elo Touch, Elo Touch Solutions, Elo TouchSystems, IntelliTouch, iTouch, SecureTouch, TouchTools and VuPoint are trademarks of Elo and its Affiliates. Windows is a trademark of Microsoft Corporation.

Table of Contents

- Chapter 1: Introduction 4**
- Chapter 2: Installation 6**
- Chapter 3: Mounting 14**
- Chapter 4: Operation 14**
- Chapter 5: Technical Support 27**
- Chapter 6: Safety & Maintenance 29**
- Chapter 7: Regulatory Information 31**
- Chapter 8: Warranty Information 36**

Chapter 1: Introduction

Product Description

Your new touchmonitor combines the reliable performance of touch technology with the latest advances in LCD display design. This combination of features creates a natural flow of information between a user and your touchmonitor.

This LCD monitor incorporates 19" color active matrix thin-film-transistor (TFT) liquid crystal display to provide superior display performance. A maximum resolution of SXGA 1280 x 1024 is ideal for displaying graphics and images. Other outstanding designs that enhance this LCD monitor's performance are Plug & Play compatibility, and OSD (On Screen Display) controls.

Precautions

Follow all warnings, precautions and maintenance as recommended in this user manual to maximize the life of your unit and prevent risks to user safety. See the Safety & Maintenance chapter for more information.

This manual contains information that is important for the proper setup and maintenance of the unit. Before setting up and powering on your new touchmonitor, read through this manual, especially the Installation and Operation chapters.

About the Product

Your LCD Desktop Touchmonitor is a 19" SXGA TFT color display with the following features:

- The internal microprocessor digitally controls auto-scanning, for horizontal scan frequencies between 31.5 KHz and 80 KHz, and vertical scan frequencies between 56.3 Hz and 75.0 Hz. In each frequency mode, the microprocessor-based circuitry allows the monitor to function at the precision-of a fixed frequency.
- High contrast color TFT LCD display supports resolutions up to SXGA 1280 x 1024. It is Compatible with VGA, SVGA, XGA, SXGA (non-interlaced) and most Macintosh compatible color video cards.
- Power management system conforms to VESA DPMS standard.
- Supports DDC2B for Plug & Play compatibility.
- Advanced OSD control for picture quality adjustment.
- Detachable stand for wall-mounting application.
- Integrated touch screen function.

Chapter 2: Installation

Unpacking the Touchmonitor

Open the carton and verify that the following items are present:

- Touchmonitor with removable protective sheet for its face
- User Manuals CD
- Quick Install Guide
- VGA cable
- USB cable
- Serial cable (excluded in APR and Intellitouch Plus models)
- Power cable
 - Japanese power cable and adapter/terminal,
 - China, Taiwan, and/or Korean power cable, or
 - US and/or European power cable

Touch Interface Connection

Note: Before connecting the cables to your touchmonitor and PC, be sure that the computer and touchmonitor are turned off.

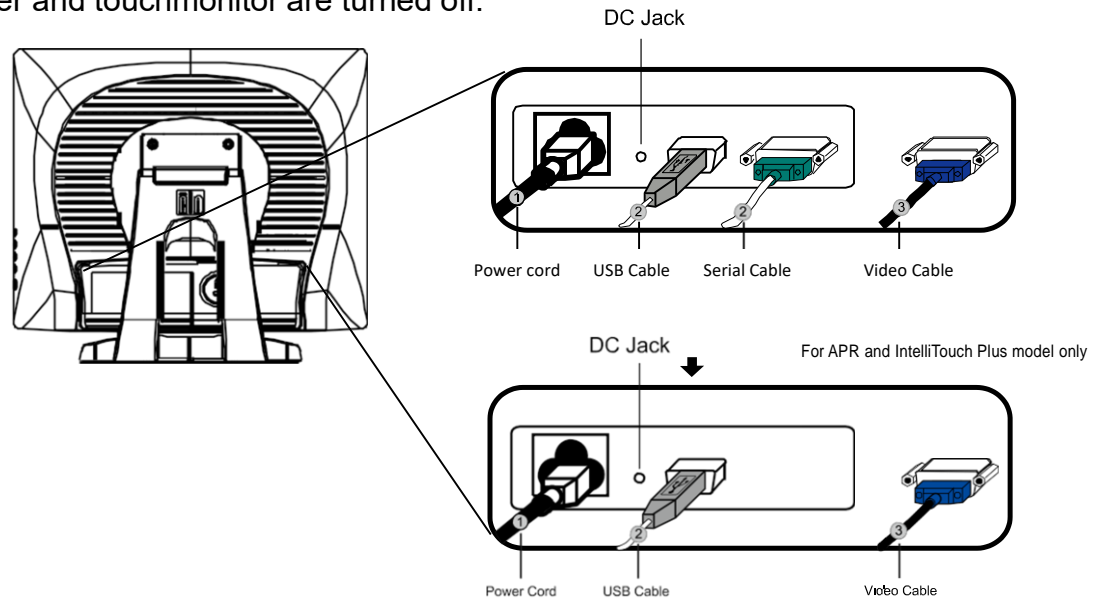

1. Connect one end of the **power cord** to the monitor and the other end to the outlet.
2. Connect one end of either the **touchscreen serial(RS232) cable** or the touch screen USB cable (but not both) to the rear side of the computer and the other end to the LCD monitor. Tighten by turning the two thumb screws clockwise to ensure proper grounding (USB cable does not have thumb screws).
3. Connect one end of the **video cable** to the rear side of computer and the other to the LCD monitor. Tighten by turning the two thumb screws clockwise to ensure proper grounding.
4. Press the **power button** on the front panel to turn the monitor power on.

Product Overview

Main Unit



Rear View

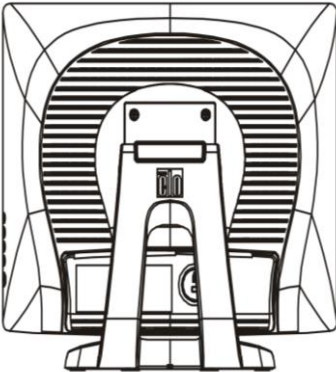

Installing the Touch Technology Software Drivers

Some software installation is required for your iTouch Plus touchmonitor to work with your computer. No additional drivers are required for your projected-capacitive touchmonitor, it uses Windows HID drivers.

The drivers for the Windows 7 and XP systems are available on the Elo Touch Solutions website.

Visit www.elotouch.com for:

- The most up-to-date touch driver versions
- Additional touch driver information
- Detailed touch driver installation guides
- Touch drivers for other operating systems

Select the applicable driver from the Elo Touch Solutions website and download:

Driver and File Downloads

[Subscribe to The Touch Monitor](#), the Elo email newsletter, for information on the latest driver releases.

[Help](#) with downloads - [Help](#) with identifying your touch technology

Archived/unsupported drivers are available [on this page](#).

Windows XP Pro operating system licensing will be valid through 2016 on Elo TouchSystems products. As well as offering additional new OS options, support of Windows XP will continue up to 2016.

The Acoustic Pulse Recognition (APR) and Projected Capacitive touch technologies are not supported by all operating systems including Mac and some versions of Linux. See the Technology notes for each driver on the Driver and File Downloads page to verify support for your touchscreen technology.

Touch Drivers

Download	OS ¹	Interface [?]	Technology [?]	Notes
Elo TouchSystems Single-touch Driver 5.4.7 (14.3 MB) 	Windows 7 ² XP Vista Windows Server 2003 Windows Server 2008 Windows POSReady	USB, Serial	Optional driver for All Elo touch technologies except Projected Capacitive and IntelliTouch Plus	Windows Hardware Quality Lab (WHQL) certified driver. Multiple monitor support.
Elo iTouch+XP driver 1.0.1 (15.0 MB) 	XP	USB	iTouch Plus only. Recommended for 1541L product with iTouch Plus touch technology.	Windows Hardware Quality Lab (WHQL) certified USB driver.

(1) Not recommended for any other OS.
(2) Multi-touch and gesturing not supported with current Elo hardware; for multi-touch and gesturing support, see Elo TouchSystems Multi-touch Driver.

(1) Not recommended for any other OS.

For **Windows 7** installations, double-click on EloSetup Installer

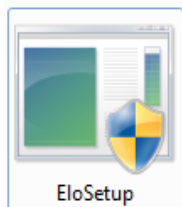

After accepting the end-user license agreement, the system will initialize to setup installation of drivers.

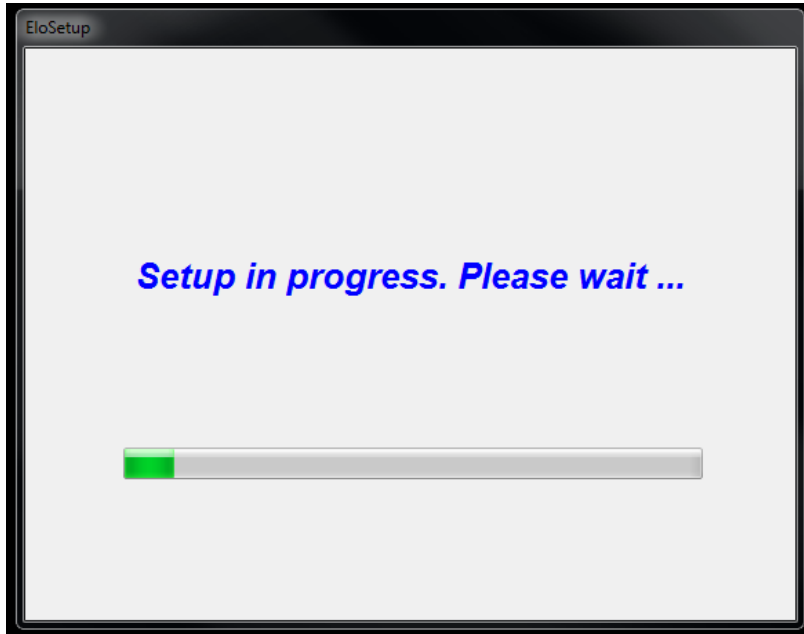

To complete setup, reboot system by clicking on "Reboot Now" button. Click on "One More Minute" if more time is needed with increments of 1 minute.

Note: System will automatically reboot when "Time left" counter reaches "0".

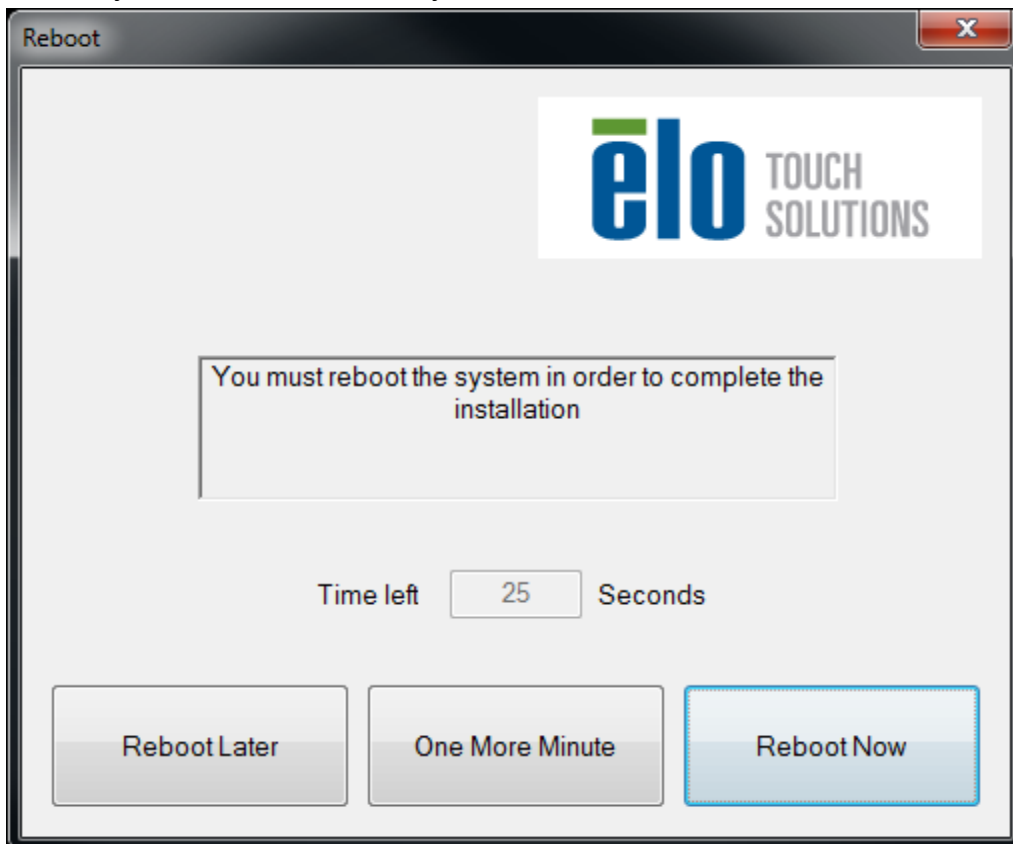

For **Windows XP** installations, double-click on the icon from the desktop



Click on “Unzip” button to unzip files.

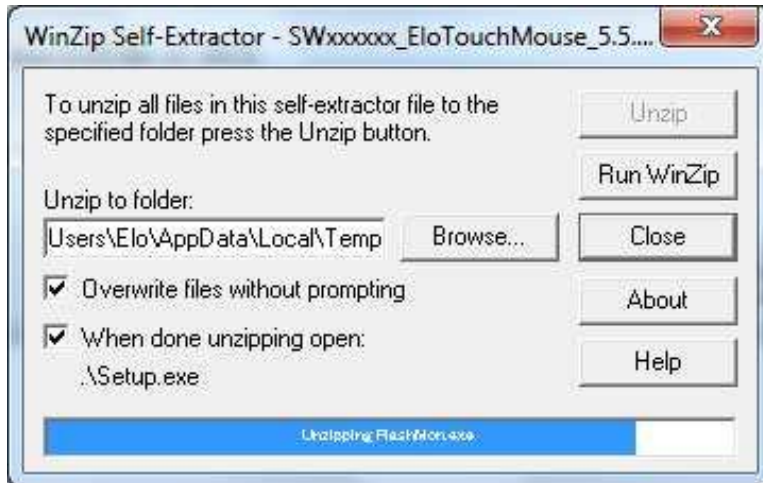

Select one or more of the drivers to install. Click on “Next”

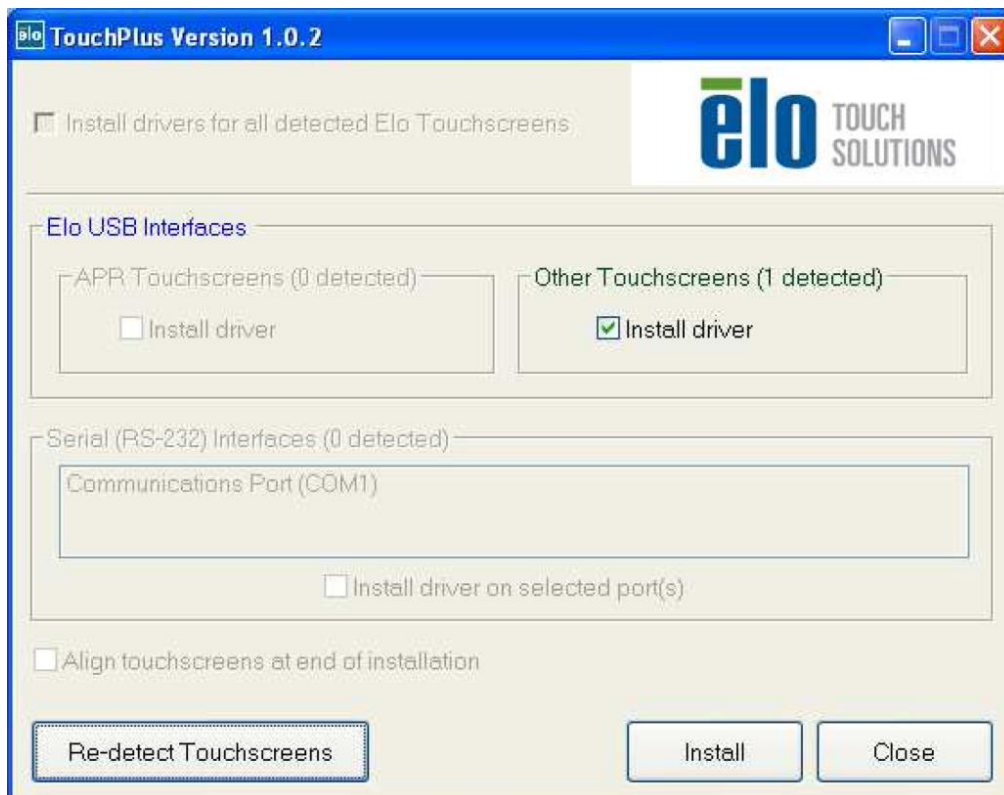

After accepting the end-user license agreement, the drivers will finish installing.

Reboot your computer after the installation is complete.

Chapter 3 – Mounting

General Mounting Information

The holes located on the sides and top of the touchmonitor case are for ventilation. Do not block, cover, or insert anything inside the ventilation slots.

Rear VESA Mount

A four-hole 100x100mm mounting pattern for M4 screws (7mm) is provided on the rear of the monitor. Remove the stand using a Phillips screwdriver to access this mounting interface. The VESA FDMI-compliant mounting is coded: VESA MIS-D, 100, C

For use only with UL Listed Wall Mount Bracket or equivalent.

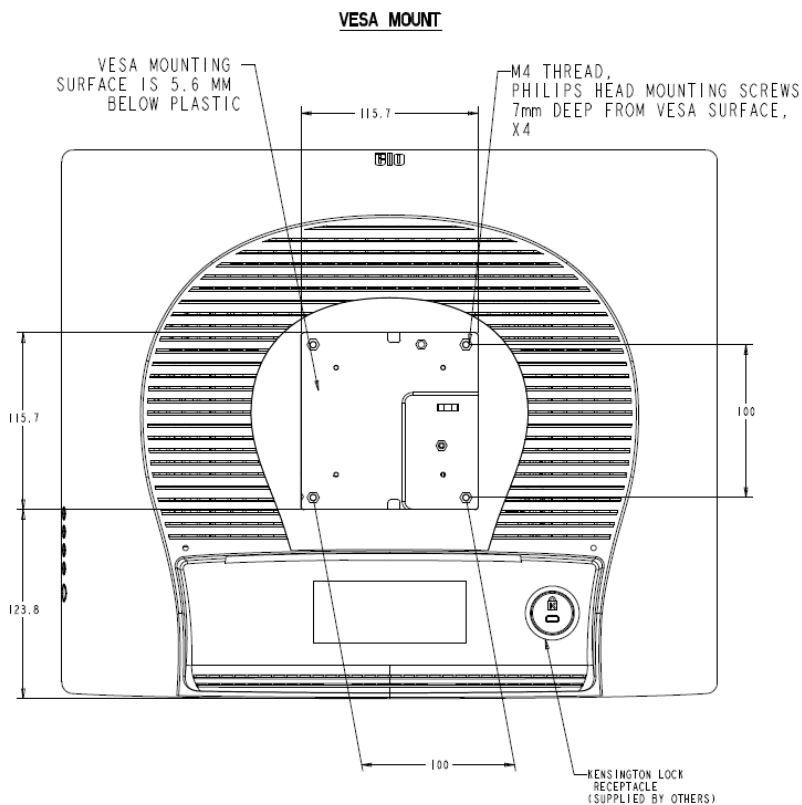

Chapter 4: Operation

About Touchmonitor Adjustments

There will most likely be no need to be adjust your touchmonitor. However, variations in video output and application may require adjustments to optimize display quality.

For best performance, your touchmonitor should be operating in its native resolution, 1280 x 1024 at 80k-75 Hz. Use the Display control panel in Windows to select the 1280 x 1024 resolution.

Operating in other resolutions will degrade video performance.

All adjustments you make to the controls are automatically memorized. This feature saves you from having to reset your choices every time you unplug or power your touchmonitor off and on. If there is a power failure, your touchmonitor settings will not default to the factory specifications.

On-Screen Display (OSD)

Four OSD buttons are on the side of the monitor.

These can be used to adjust various display parameters.



The buttons and their functionality are:

Button	Function when OSD is not displayed:	Function when OSD is displayed:
Menu	Display OSD main menu	Return to previous OSD menu
◀	Display OSD Brightness submenu	Decrease value of selected parameter / select previous menu item
▶	Display OSD Contrast submenu	Increase value of selected parameter / select next menu item
Select	Auto Adjust	Select parameter for adjustment / select submenu to enter



The OSD buttons control an on-screen graphical user interface, which displays on top of your input video. This allows for intuitive adjustment of the following display parameters:

Parameter	Available Adjustment
Brightness	Increase/decrease monitor brightness Default: Maximum
Contrast	Increase/decrease monitor contrast Default: Best gray-shade performance
Clock	Allows fine adjustments of the panel's pixel dot clock <i>Only applicable for VGA input video</i>
Phase	Allows fine adjustments of the panel's pixel dot clock phase <i>Only applicable for VGA input video</i>
Auto Adjust	Automatically adjusts the system clock to the input analog VGA video signal, affecting the H-position, V-position, Clock, and Phase menu items <i>Only applicable for VGA input video</i>
H-position	Moves the image horizontally on the display in single-pixel increments Default: Centered <i>Only applicable for VGA input video</i>
V-position	Moves the image vertically on the display in single-pixel increments Default: Centered <i>Only applicable for VGA input video</i>
Sharpness	Adjusts sharpness of the displayed images Default: No sharpness adjustment <i>Only applicable at non-native input video resolutions</i>
Color Temperature	Selects the display's color temperature. The available color temperatures are 9300K, 7500K, 6500K, 5500K, and User Defined. If the User Defined option is selected, the user can change the color temperature by changing individual R, G, and B gains on a scale from 0 to 100. Default: User Defined with R, G, and B all set to 100
OSD Timeout	Adjusts how long a period of OSD button inactivity the touchmonitor will wait before closing the OSD. The adjustable range is between 5 and 60 seconds. Default: 15 seconds
OSD Language	Selects which language the OSD information is displayed in. The available languages are: English, French, Italian, German, Spanish, Simplified Chinese, Traditional Chinese, and Japanese Default: English
Volume	Adjusts the volume of the internal speakers and headphone output
Mute	Toggles the audio output between Muted and Not Muted Default: Not Muted
Recall Defaults	Selecting "Recall Defaults" restores all factory default settings for OSD-adjustable parameters (except OSD Language) and for Preset Video Mode timings.



Video Source	The monitor continually scans for active video on the VGA and DVI connectors. This adjustment selects which of those input ports should be given priority to be displayed. The options are: VGA Priority, DVI Priority Default: DVI Priority
---------------------	--

All touchmonitor adjustments made through the OSD are automatically memorized as soon as they are entered. This feature saves you from having to reset your choices every time the touchmonitor is unplugged or powered off and on. If there is a power failure, the touchmonitor settings will not default to the factory specifications.

OSD and Power Lockouts

Press and hold the “Menu” and “Up” buttons for two seconds to enable/disable the OSD Locking feature. When the OSD Locking is enabled, pressing any of the Menu, Up, Down, or Select keys will have no effect on the system.

Press and hold the “Menu” and “Down” buttons for two seconds to enable/disable the Power Locking feature. When the Power Locking is enabled, pressing the power switch will have no effect on the system.



Preset Modes

To reduce the need for adjustment for different modes, the monitor has default setting modes that are most commonly used as given in the table below. If any of these display modes are detected, the monitor automatically adjusts the picture size and centering. When none of the mode is matched, the user can store their preferred modes in the user modes. The monitor is capable of storing up to 7 user modes. The only condition to store as a user mode is the new display information must have 1 KHz difference for horizontal frequency or 1 Hz for vertical frequency or the sync signal polarities are different from the default modes.

Item	Resolution	Type	H.Scan(KHz)	V. Scan(Hz)	Polarity
1	640 x 350	VGA	31.468	70.09	+/-
2	720 x 400	VGA	31.468	70.08	-/+
3	640 x 480	VGA	31.468	59.94	-/-
4	640 x 480	MAC 66	35	66	-/-
5	640 x 480	VESA 72	37.861	72.809	-/-
6	640 x 480	VESA 75	37.5	75	-/-
7	800 x 600	VESA 56	35.156	56.25	+/+
8	800 x 600	VESA 60	37.879	60.317	+/+
9	800 x 600	VESA 75	46.875	75	+/+
10	800 x 600	VESA 72	48.077	72.188	+/+
11	832 x 624	MAC 75	49.71	74.53	-/-
12	1024 x 768	VESA 60	48.363	60.004	-/-
13	1024 x 768	SUN 65	52.45	65	-/-
14	1024 x 768	VESA 70	56.476	70.069	-/-
15	1024 x 768	VESA 75	60.023	75.029	+/+
16	1280 x 1024	VESA 60	63.981	60	+/+
17	1280 x 1024	VESA 75	79.976	75.025	+/+
18	1152 x 864	VESA 75	67.5	75	+/+
19	1280 x 960	VESA 60	60	60	+/+

Power Management System

The monitor is equipped with the power management function which automatically reduces the power consumption when not in use.

Mode	Power Consumption
------	-------------------

On	< 50 Watts
Sleep	< 3 Watts
Off	< 1 Watt

We recommend switching the monitor off when it is not in use for a long time.

NOTE: The monitor automatically goes through the Power Management System (PMS) steps when it is idle. To release the monitor from PMS state, press any key on the keyboard or move mouse.

Display Angle

For viewing clarity, you can tilt the LCD forward (up to -5 degrees) or backward (up to 90 degrees.)

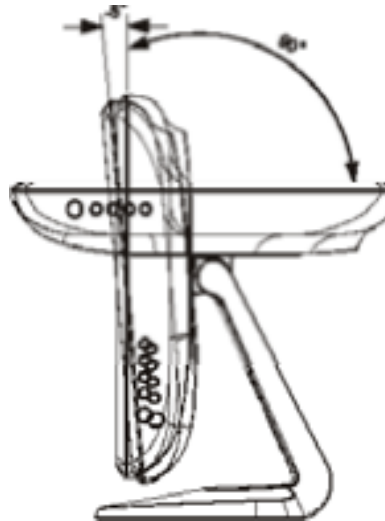

CAUTION: In order to protect the LCD, be sure to hold the base when adjusting the LCD, and take care not to touch the screen.



Intellitouch Plus Touch Technology

When connected to Windows 7 computers, the touchmonitor can report two simultaneous touches. The IntelliTouch Plus touchscreen can be re-calibrated to your displayed video image, if needed, through the Calibration function in the Elo driver control panel.

The IntelliTouch Plus driver will only support multiple monitor if they are all using the IntelliTouch Plus touchscreen technology.

To use multiple IntelliTouch Plus monitors, plug in monitors to calibrate, double-click on the EloConfig desktop shortcut to run Elo Touchscreen Configuration screen.



Click on “Calibrate Touch Screens...” to calibrate multiple monitors.

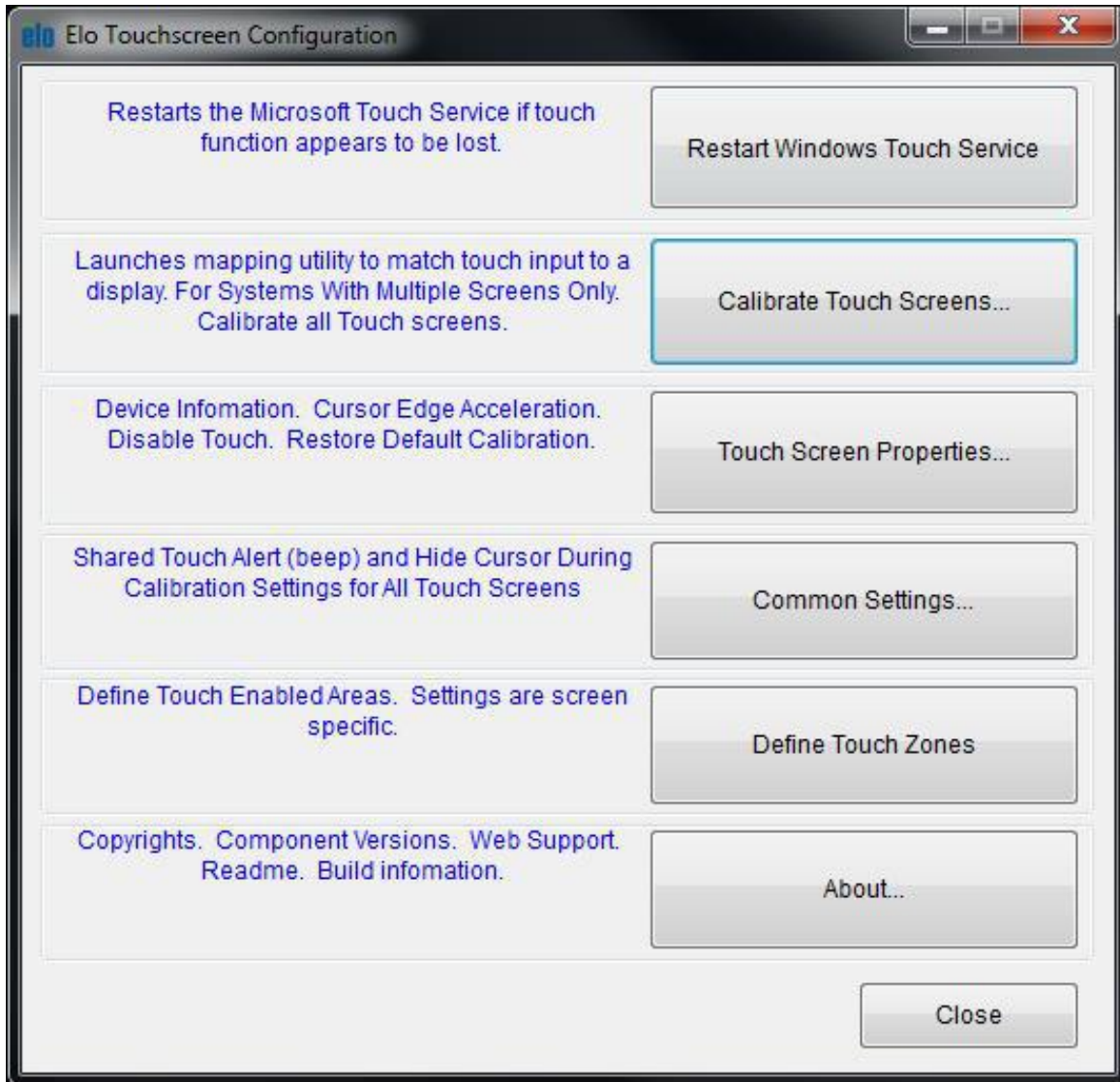



Tap monitor screen to identify monitor's identity as shown below.

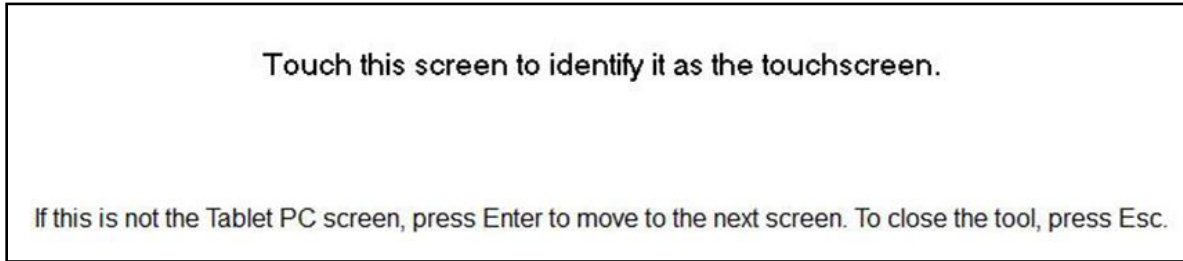

Identity of the monitor will display. Click on “OK” to proceed to calibration.

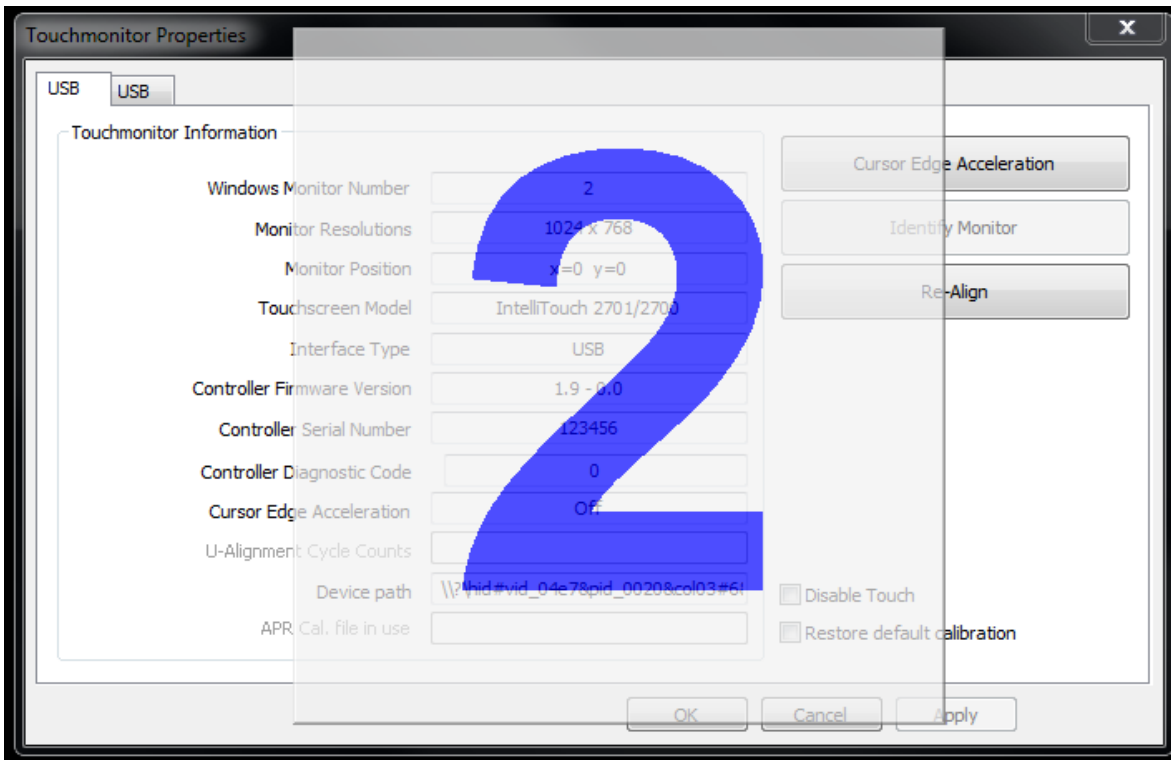



Calibrate touch as targets appear on corners of the screen. Follow instructions on screen.

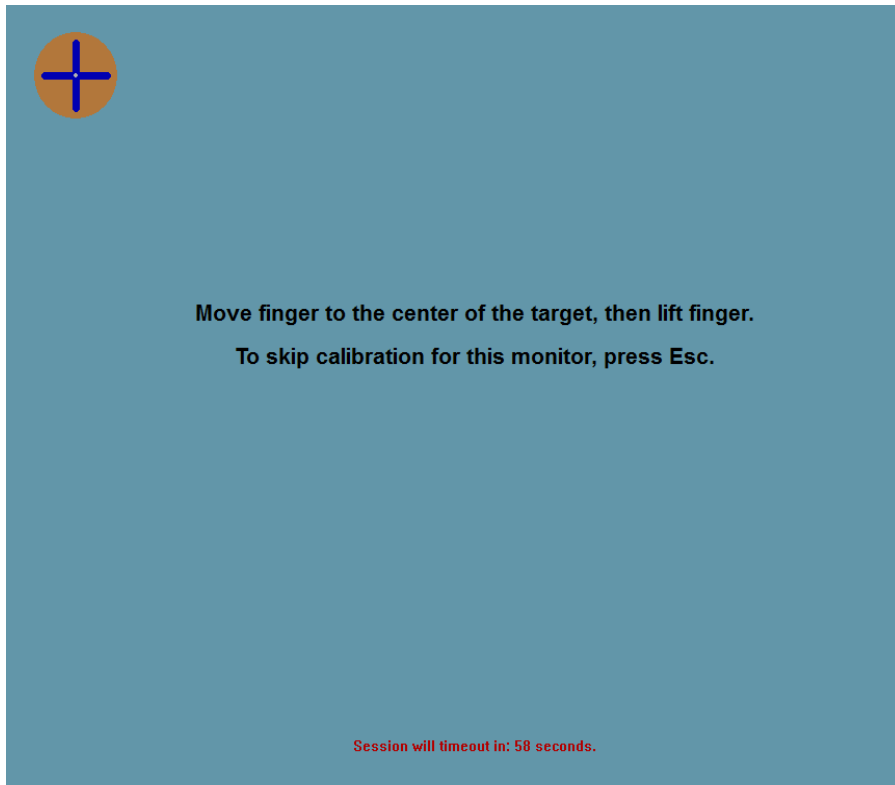

Test touch/drag performance to verify calibration accuracy, “Accept” or “Retry” to redo calibration process.

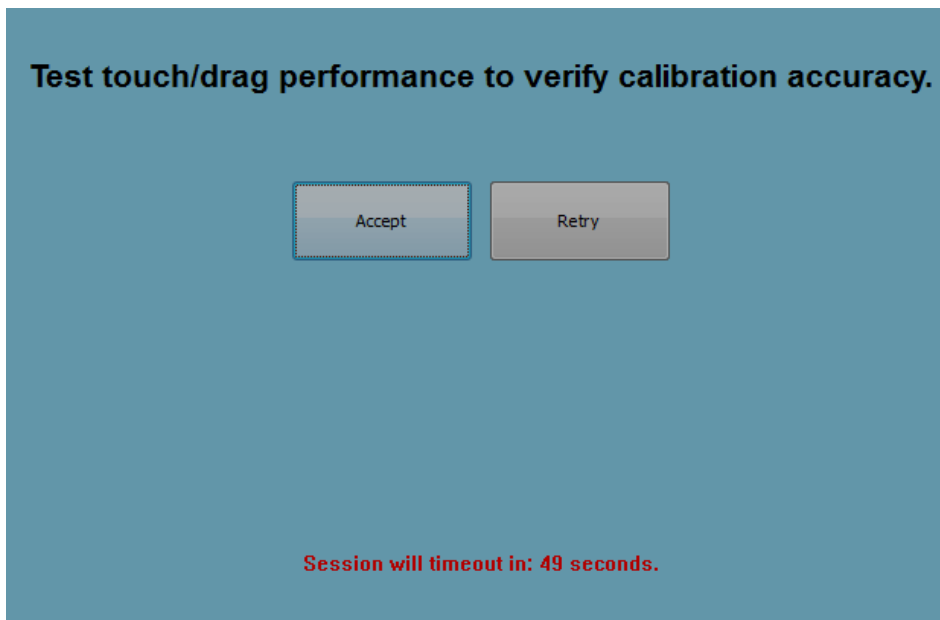



Run touch calibration on each monitor that is plugged in.



Gesture Support

The IntelliTouch Plus and Projected Capacitive touch technologies enable several gestures that support single and multiple contacts. Refer to the Microsoft Website <http://msdn.microsoft.com/en-us/library/dd940543> on the various gestures that are supported in Windows 7.



Chapter 5: Technical Support

If you are experiencing trouble with your touchmonitor, refer to the following suggestions.

If the problem persists, please contact your local dealer or contact Elo Touch Solutions Customer Service.

Solutions to Common Problems

Problem	Suggested Troubleshooting
The touchmonitor does not respond when turning on the system	Check that the DC power adaptor is properly connected Verify the DC power adaptor is functioning
Monitor display is dim	Use the OSD to increase the brightness Use the OSD to increase the contrast
Monitor display is blank	If the Power Status LED is blinking, the monitor or Computer Module may be in SLEEP mode. Press any key / move the mouse / touch the Touchscreen to see if the image reappears Check that the signal source device is turned on Check that that there are no loose cable connections
Monitor displays an “Out Of Range” message	Adjust your computer’s resolution/timing mode to be within the allowable timing ranges specified for your touchmonitor (see website for specifications)
Monitor display image looks abnormal	Adjust your computer’s resolution/timing mode to be within the allowable timing ranges specified for your touchmonitor (see website for specifications) Use the Auto Adjust function in the OSD
Touch functionality doesn’t work	Verify your PC has the latest Elo drivers installed Perform the calibration routine provided with the latest Elo drivers
The OSD buttons or power button does not respond when pressed	Check to see if the OSD lock or power lock functions are on



Technical Assistance

Visit www.elotouch.com/products for technical specifications for this device

Visit www.elotouch.com/go/websupport for online self-help.

Visit www.elotouch.com/go/contactsupport for technical support.

See this user manual's last page for worldwide technical support phone numbers.



Chapter 6: Safety & Maintenance

Safety

To avoid risk of electric shock, follow all safety notices and do not disassemble the touchmonitor. They are not user-serviceable.

The slots located on the sides and top of the touchmonitor case are for ventilation. Do not block or insert anything inside the ventilation slots.

The touchmonitor ships with a 3-wire, grounding power cord. The power cord plug only fits into a grounded outlet. Do not fit or modify the plug into an outlet that has not been configured for this purpose. Do not use a damaged power cord. Only use the power cord that came with your ELO touchmonitor. Use of an unauthorized power cord might invalidate your warranty.

Ensure that your installation is equipped to maintain the specified environmental conditions listed in the Technical Specifications chapter.

Care and Handling

The following tips will help keep your touchmonitor functioning at an optimal level:

- Disconnect the AC power cable before cleaning.
- To clean the display unit cabinet, use a clean cloth lightly dampened with a mild detergent.
- It is important that your unit remains dry. Do not get liquids on or inside the unit. If liquid does get inside, have a qualified service technician check it before you power it on again.
- Do not wipe the screen with a cloth or sponge that could scratch the surface.
- To clean the touchscreen, use window or glass cleaner applied to a clean cloth or sponge. Never apply the cleaner directly to the touchscreen. Do not use alcohol (methyl, ethyl or isopropyl), thinner, benzene, or other abrasive cleaners.



Waste Electrical & Electronic Equipment Directive (WEEE)



This product should not be disposed of with household waste. It should be deposited at a facility that enables recovery and recycling. Ensure that product is disposed at the end of its useful life according to local laws and regulation.

Elo has put in place recycling arrangements in certain parts of the world. For information on how you can access these arrangements, please visit <http://www.elotouch.com/AboutElo/ewaste-program/>.



Chapter 7: Regulatory Information

I. Electrical Safety Information:

Compliance is required with respect to the voltage, frequency, and current requirements indicated on the manufacturer's label. Connection to a different power source than those specified herein will likely result in improper operation, damage to the equipment or pose a fire hazard if the limitations are not followed.

There are no operator serviceable parts inside this equipment. There are hazardous voltages generated by this equipment which constitute a safety hazard. Service should be provided only by a qualified service technician.

Contact a qualified electrician or the manufacturer if there are questions about the installation prior to connecting the equipment to mains power.

The equipment power supply cord shall be connected to a socket-outlet with earthing connection.

II. Emissions and Immunity Information

Notice to Users in the United States:

This equipment has been tested and found to comply with the limits for a Class B digital device, pursuant to Part 15 of the FCC Rules. These limits are designed to provide reasonable protection against harmful interference in a residential installation. This equipment generates, uses and can radiate radio frequency energy and, if not installed and used in accordance with the instructions, may cause harmful interference to radio communications. However, there is no guarantee that interference will not occur in a particular installation. If this equipment does cause harmful interference to radio or television reception, which can be determined by turning the equipment off and on, the user is encouraged to try to correct the interference by one or more of the following measures:

-- Reorient or relocate the receiving antenna.

-- Increase the separation between the equipment and receiver.

-- Connect the equipment into an outlet on a circuit different from that to which the receiver is connected.

-- Consult the dealer or an experienced radio/TV technician for help.

**Notice to Users in Canada:**

This equipment complies with the Class B limits for radio noise emissions from digital apparatus as established by the Radio Interference Regulations of Industrial Canada.

CAN ICES3(B)/NMB3(B)

This device complies with Industry Canada's license-exempt RSSs. Operation is subject to the following two conditions:

- (1) This device may not cause interference; and
- (2) This device must accept any interference, including interference that may cause undesired operation of the device.

Le présent appareil est conforme aux CNR d'Industrie Canada applicables aux appareils radio exempts de licence. L'exploitation est autorisée aux deux conditions suivantes :

- (1) l'appareil ne doit pas produire de brouillage; et
- (2) l'utilisateur de l'appareil doit accepter tout brouillage radioélectrique subi, même si le brouillage est susceptible d'en compromettre le fonctionnement.

Notice to Users in the European Union: Use only the provided power cords and interconnecting cabling provided with the equipment. Substitution of provided cords and cabling may compromise electrical safety or CE Mark Certification for emissions or immunity as required by the following standards:

This Information Technology Equipment (ITE) is required to have a CE Mark on the Manufacturer's label which means that the equipment has been tested to the following Directives and Standards: This equipment has been tested to the requirements for the CE Mark as required by EMC Directive 2014/30/EU as indicated in European Standard EN 55032 Class B and the Low Voltage Directive 2014/35/EU as indicated in European Standard EN 60950-1.

General Information to all Users: This equipment generates, uses and can radiate radio frequency energy. If not installed and used according to this manual the equipment may cause interference with radio and television communications. There is, however, no guarantee that interference will not occur in any particular installation due to site-specific factors.

1) In order to meet emission and immunity requirements, the user must observe the following:

- a) Use only the provided I/O cables to connect this digital device with any computer.
- b) To ensure compliance, use only the provided manufacturer's approved line cord.



c) The user is cautioned that changes or modifications to the equipment not expressly approved by the party responsible for compliance could void the user's authority to operate the equipment.

2) If this equipment appears to cause interference with radio or television reception, or any other device:

a) Verify as an emission source by turning the equipment off and on.

If you determine that this equipment is causing the interference, try to correct the interference by using one or more of the following measures:

i) Move the digital device away from the affected receiver.

ii) Reposition (turn) the digital device with respect to the affected receiver.

iii) Reorient the affected receiver's antenna.

iv) Plug the digital device into a different AC outlet so the digital device and the receiver are on different branch circuits.

v) Disconnect and remove any I/O cables that the digital device does not use. (Unterminated I/O cables are a potential source of high RF emission levels.)

vi) Plug the digital device into only a grounded outlet receptacle. Do not use AC adapter plugs. (Removing or cutting the line cord ground may increase RF emission levels and may also present a lethal shock hazard to the user.)

If you need additional help, consult your dealer, manufacturer, or an experienced radio or television technician.



24 September 2019

FCC Declaration of Conformity

Per FCC 47 CFR FCC Part15 subpart B Section 2.1077(a)

In accordance with FCC Rules and Regulations

Model Number: ET1515L/ET1715L/ET1915L Series
Equipment Category: Information Technology and Telecommunications Equipment
Equipment Class: Commercial and Light Industrial
Product Name: Monitor

Manufacturer: Elo Touch Solutions, Inc.
670 N. McCarthy Blvd.
Suite 100
Milpitas, CA 95035
www.elotouch.com

Trademark:



Declaration:

This device complies with Part 15 of the FCC Rules. Operation is subject to the following two conditions:

(1) This device may not cause harmful interference, and (2) this device must accept any interference received, including interference that may cause undesired operation

Kevin Huang

Director, Systems Engineering

Elo Touch Solutions, Inc.

III. Agency Certifications

The following certifications and marks have been issued or declared for this monitor:

- North America/Worldwide: USA UL, Canada cUL
- EMEA: Germany TUV, Sweden MPRII
- Asia: Australia C-Tick, China CCC, Japan VCCI, Korea MIC Taiwan BSMI
- Elo Declarations: RoHS, China RoHS, WEEE, IMERC, CE, FCC/ICES Class B

IV. China RoHS

In accordance to Chinese law (Management Methods for the Restriction of the Use of Hazardous Substances in Electrical and Electronic Products), the section below lists out the name and amount of the toxic and/or hazardous materials that this product may contain.

根据中国法律《电器电子产品有害物质限制使用管理办法》，以下部分列出了产品中可能包含的有害物质的名称和含量。

液晶触控显示器	有害物质					
	铅 (Pb)	汞 (Hg)	镉 (Cd)	六价铬 (Cr6+)	多溴联苯 (PBB)	多溴联苯醚 (PBDE)
塑料部件	O	O	O	O	O	O
金属零件	X	O	O	O	O	O
电线和电缆组件	X	O	O	O	O	O
液晶显示面板	X	O	O	O	O	O
触摸屏面板	X	O	O	O	O	O
PCBA	X	O	O	O	O	O

本表格依据SJ/T 11364的规定编制。

O: 表示该有害物质在该部件所有均质材料中的含量均在GB/T 26572规定的限量要求以下。

X: 表示该有害物质至少在该部件的某一均质材料中的含量超出GB/T 26572规定的限量要求。

上表中打“X”的部件中，应功能需要，部分有害物质含量超出GB/T 26572规定的限量要求，但是符合**欧盟RoHS**法规要求(属于豁免部分)。



Chapter 8: Warranty Information

See <http://www.elotouch.com/Support/warranty.asp> for more information



Check out Our Website!

www.elotouch.com

Get the latest...

- Product Information
- Specifications
- Upcoming events
- Press releases
- Software drivers

Getting in Touch with us

To find out more about the extensive range of Elo touch solutions, visit our website at www.elotouch.com, or simply call the office nearest you:

North America

Elo Touch Solutions
670 N. McCarthy Blvd
Suite 100
Milpitas, CA 95035

Tel 800-ELO-TOUCH
Tel 1-408-597-8000
Fax 1-408-597-8001
customerservice@elotouch.com

Europe

Tel +32(0)(16)35-2100
Fax +32(0)(16)35-2101
elosales@elotouch.com

Asia-Pacific

Tel +81(45)478-2161
Fax +81(45)478-2180
www.tps.co.jp

Latin America

Tel 786-923-0251
Fax 305-931-0124
www.elotouch.com

Copyright 2016 Elo Touch Solutions, Inc. All rights reserved.